

Petrothene LS 5060-00: High Density Polyethylene Injection Molding Grade

Applications: This resin exhibits excellent stiffness and impact and warp resistance. Typical Applications are pails, containers, and lids.

Certification: This material meets the requirements of the Food and Drug Administration regulation 21CFR Section 177.1520. This regulation allows the use of this olefin polymer in "...articles or compnents of articles intended for use in contact with food." Specific limitations or conditions of use may apply.

Processing Techniques: Specific recommendations for processing LS 5060-00 can only be made when the process conditions, equipment and end use are known.

PHYSICAL PROPERTIES

PROPERTY	NOM. VALUE	UNITS	ASTM METHOD
DENSITY	0.948	g/cm ³	D1505
MELT INDEX	8.0	g/10 min	D1238
TENSILE STRENGTH	3,800	psi	D638
ELOGATION	970	%	D638
FLEXURAL MODULUS	145,00	psi	D790
TENSILE IMPACT	3,800	ft.-lb.	D1822
LOW TEMP BRITTLINESS	<-76	0 deg. C	D746
VICAT SOFTENING	123	0 deg. C	D1525
HARDNESS, SHORE D	65		D2240

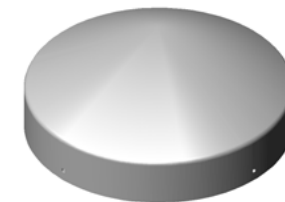
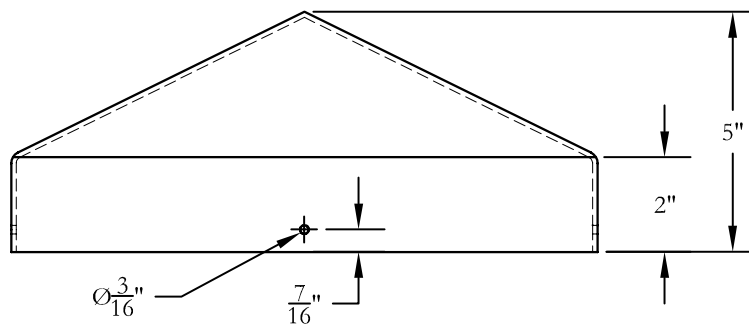
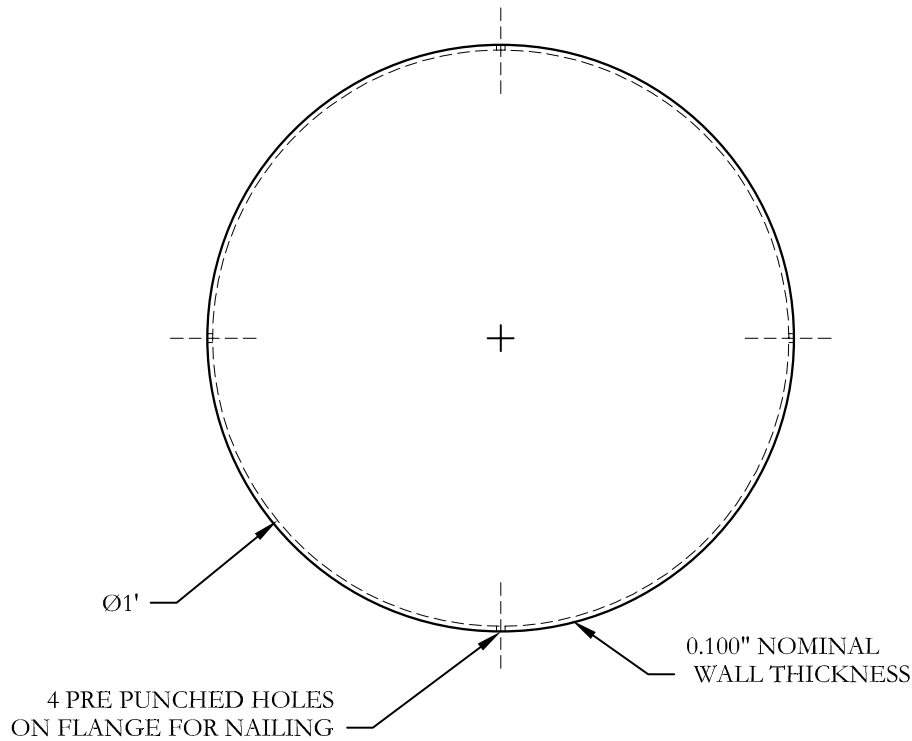

VISIT US ON THE WEB AT WWW.MERCOMARINE.COM

ALL DRAWINGS AND DETAILS ARE PROPERTY OF MERCO MARINE DO NOT COPY

MERCO MARINE
60 MERCO ROAD
WELLSBURG, WV 26070
PHONE: (800)396-3726
FAX: (304)737-3008



TITLE:	PCB-12 PCW-12 12" PILE CAP	SCALE:	3" = 1'-0"
DATE:	12/11/2006 2:46 PM	DRAWN BY:	DAN OTTO
		APRVD BY:	J. MERIWETHER